

Disconnect test terminals

WTL 6/1 EN with accessories

NEW

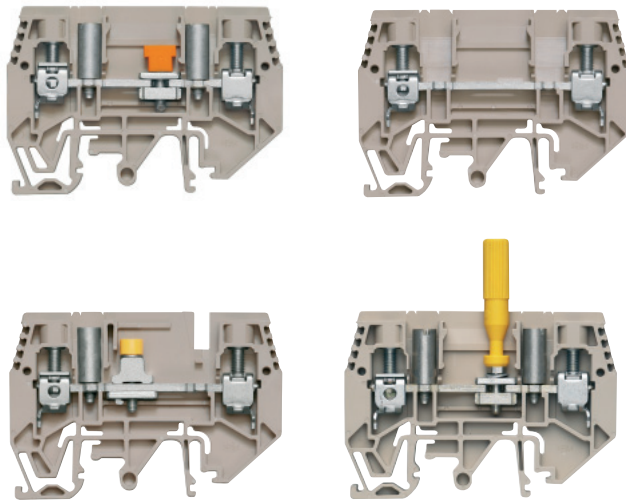

The disconnect test terminal WTL 6/1 EN enables you to carry out performance measurements quickly and unconventionally.

Trouble-free measurements of current or voltage converters are possible using the comprehensive assortment of longitudinal, feed-through/disconnect and cross-connect/disconnect terminals and their accessories.

- Cross-section range 0.5 ... 10 mm²
- The most diverse types of partition and end plates
- Very compact size with combi foot for DIN rail TS 32 and TS 35
- Easy handling of the new cross slider and cross connectors
- Finger-proof sockets and test plugs
- WQV 6/... standard cross-connectors usable
- Large marking area for standard markers
- Handling of the new slider without any tools possible

United Kingdom

Weidmüller Ltd.
1 Abbey Wood Road
Kings Hill
West Malling
Kent ME19 4YT
Phone +44 1732 877000
Fax +44 1732 873873
info@weidmuller.co.uk
www.weidmueller.com

USA

W-Interconnections, Inc.
821 Southlake Boulevard,
Richmond, VA 23236
Phone +1 804 7942877
Fax +1 804 3792593
info@weidmuller.com
www.weidmuller.com

Other countries

Weidmüller Interface GmbH & Co. KG
P.O. Box 3030
32720 Detmold
Phone +49 5231 14-0
Fax +49 5231 14-20 83
info@weidmueller.com
www.weidmueller.com

Disconnect test terminals

Different current transformer circuits, e.g. for replacing measuring instruments or electricity meters, can be realised.

WTL 6/1 EN

6 mm²

Longitudinal – disconnect

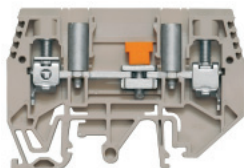

WTD 6/1 EN

6 mm²

Continuity

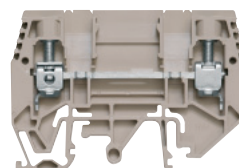

width/length/height with TS35x7.5/TS32x7.5 mm
 max. current / max. cond. cross-section A/mm²
 max. clamping range mm²

7.9 x 68.5 x 48.5 - 53

57 / 10

10

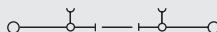

7.9 x 68.5 x 48.5 - 53

57 / 10

10

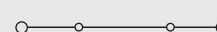

Technical data

Rated data	
Rated voltage	V
Rated current	A
Rated cross-section	mm ²
Rated impulse withstand voltage / Pollution severity	kV/-
Gauge to IEC 60947-1 / UL94 Flammability class	
Approvals	

IEC	UL	CSA
630	300	300
41	45	45
6	AWG 20 ... 8	AWG 20 ... 8
6 / 3		
A5 / V-0		

IEC	UL	CSA
800	300	300
41	45	45
6	AWG 20 ... 8	AWG 20 ... 8
8 / 3		
A5 / V-0		

Clamped conductors (H05V/H07V)

Solid / stranded	mm ²
Flexible / Flexible with wire end ferrule	mm ²
Tightening torque range (clamping screw)	Nm
Tightening torque range (disconnecter)	Nm
Stripping length / Blade size	mm/-

Rated connection

0.5 ... 10 / 1.5 ... 10
0.5 ... 10 / 0.5 ... 6
0.8 ... 1.0
0.5 ... 0.8
12 / 4 x 0.8

Rated connection

0.5 ... 10 / 1.5 ... 10
0.5 ... 10 / 0.5 ... 6
0.8 ... 1.0
12 / 4 x 0.8

Note

Ordering data

Version	
dark beige Wemid	with socket
	without socket

Type	Qty.	Order No.
WTL 6/1 EN	50	1934810000
WTL 6/1 EN STB	50	1934820000

Type	Qty.	Order No.
WTD 6/1 EN	50	1934830000

Note

Accessories

Cross-connection (screwed)	
(WQV)	2-pole
	3-pole
	4-pole
	10-pole

End plate / Partition plate	
dark beige Wemid	End plate
	Partition plate
	Partition plate

Cross-connection slider / bridge / partition plate

Testing / Checking

Miscellaneous accessories

Lockout device	SSP 3 SAKT1	100	0531760000	
Shorting plug, 2-pole	QS 2	20	0270960000	
without insulating cap	Socket	STB 14/D6/4/M3 SAK10	50	0169900000
Marking systems (see large assortment in catalogue 7)	Marking tags	WS 12/6		

Type	width [mm]	Qty.	Order No.
WQV 6/2		50	1052360000
WQV 6/3		50	1054760000
WQV 6/4		50	1054860000
WQV 6/10		20	1052260000

WAP WTL 6/1 L	1.5	20	1957710000
WTW WTL 6/1 DB	1.5	20	1068400000
WTW / WTL 6/1	4	20	1766900000

see page 4

see page 4

Type	width [mm]	Qty.	Order No.
WQV 6/2		50	1052360000
WQV 6/3		50	1054760000
WQV 6/4		50	1054860000
WQV 6/10		20	1052260000

WAP WTL 6/1 L	1.5	20	1957710000
WTW WTL 6/1 DB	1.5	20	1068400000
WTW / WTL 6/1	4	20	1766900000

see page 4

see page 4

STB 14/D6/4/M3 SAK10	50	0169900000
----------------------	----	------------

WS 12/6

Different current transformer circuits, e.g. for replacing measuring instruments or electricity meters, can be realised.

WTQ 6/1 EN

6 mm²

Cross-connect/disconnect

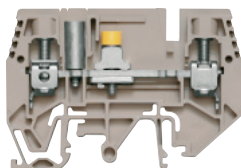

7.9 x 68.5 x 48.5 - 53

57 / 10

10

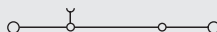

WTL 6/1/STB/TNSC/EN

6 mm²

Longitudinal – disconnect

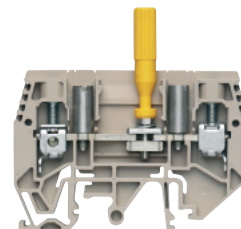

7.9 x 68.5 x 66 - 70.5

57 / 10

10

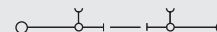

width/length/height with TS35x7.5/TS32x7.5 mm
 max. current / max. cond. cross-section A/mm²
 max. clamping range mm²

Technical data

Rated data	
Rated voltage	V
Rated current	A
Rated cross-section	mm ²
Rated impulse withstand voltage / Pollution severity	kV/-
Gauge to IEC 60947-1 / UL94 Flammability class	
Approvals	

Clamped conductors (H05V/H07V)	
Solid / stranded	mm ²
Flexible / Flexible with wire end ferrule	mm ²
Tightening torque range (clamping screw)	Nm
Tightening torque range (disconnecter)	Nm
Stripping length / Blade size	mm/-

IEC	UL	CSA
500	300	300
41	45	45
6	AWG 20 ... 8	AWG 20 ... 8
	6 / 3	6 / 3
	A5 / V-0	A5 / V-0

Rated connection	
0.5 ... 10 / 1.5 ... 10	
0.5 ... 10 / 0.5 ... 6	
0.8 ... 1.0	
0.5 ... 0.8	
12 / 4 x 0.8	

IEC	UL	CSA
630	300	300
41	45	45
6	AWG 20 ... 8	AWG 20 ... 8
	6 / 3	6 / 3
	A5 / V-0	A5 / V-0

Rated connection	
0.5 ... 10 / 1.5 ... 10	
0.5 ... 10 / 0.5 ... 6	
0.8 ... 1.0	
0.5 ... 0.8	
12 / 4 x 0.8	

Note

Ordering data

Version	
dark beige Wemid	with socket
	without socket

Type	Qty.	Order No.
WTQ 6/1 EN	50	1934790000
WTQ 6/1 EN STB	50	1934800000

Type	Qty.	Order No.
WTL 6/1/STB/TNSC/EN	50	1938820000

Note

Accessories

Cross-connection (screwed)	
(WQV)	2-pole
	3-pole
	4-pole
	10-pole

End plate / Partition plate	
dark beige Wemid	End plate
	Partition plate
	Partition plate

Cross-connection slider / bridge / partition plate

Testing / Checking

Miscellaneous accessories

Lockout device	SSP 3 SAKT1	100	0531760000	
Shorting plug, 2-pole	QS 2	20	0270960000	
without insulating cap	Socket	STB 14/D6/4/M3 SAK10	50	0169900000
Marking systems (see large assortment in catalogue 7)	Marking tags	WS 12/6		

Type	width [mm]	Qty.	Order No.
WQV 6/2		50	1052360000
WQV 6/3		50	1054760000
WQV 6/4		50	1054860000
WQV 6/10		20	1052260000

WAP WTL 6/1 L	1.5	20	1957710000
WTW WTL 6/1 DB	1.5	20	1068400000
WTW / WTL 6/1	4	20	1766900000

see page 4

see page 4

Type	width [mm]	Qty.	Order No.
WQV 6/2		50	1052360000
WQV 6/3		50	1054760000
WQV 6/4		50	1054860000
WQV 6/10		20	1052260000

WAP WTL 6/1 L	1.5	20	1957710000
WTW WTL 6/1 DB	1.5	20	1068400000
WTW / WTL 6/1	4	20	1766900000

see page 4

see page 4

QS 2	20	0270960000
STB 14/D6/4/M3 SAK10	50	0169900000

WS 12/6

Disconnect test terminals

Accessories

Cross-connection slider / bridge / partition plate		Type	No. of poles	Qty.	Order No.	For terminal:	
(WKS)		WKS 2/2	2	50	1936140000	WTL 6/1 EN	
		WKS 2/3	3	50	1936150000	WTD 6/1 EN	
		WKS 2/4	4	50	1936160000	WTQ 6/1 EN	
		WKS 2/5	5	50	1936170000	WTL 6/1/STB/TNSC/EN	
		WKS 2/10	10	20	1936180000		
(WKB)		WKB 2/2	2	20	1936190000		
		WKB 2/3	3	50	1936200000		
		WKB 2/4	4	50	1936210000		
		WKB 2/5	5	50	1936220000		
		WKB 2/10	10	20	1936230000		
Testing / Checking		Type	Colour	Qty.	Order No.	For terminal:	
(STB)	 Test plug	PS 4		20	0299600000	WTL 6/1 EN	
							WTD 6/1 EN
							WTQ 6/1 EN
							WTL 6/1/STB/TNSC/EN
		Socket	STB 21.6/45 GE	yellow	50	1936240000	
			STB 21.6/45 GN	green	50	1936250000	
			STB 21.6/45 VI	violet	50	1936260000	
			STB 21.6/45 SW	black	50	1936270000	
			STB 21.6/45 GR	grey	50	1936280000	
			STB 21.6/45 BL	blue	50	1936290000	
(VH)	Connecting sleeve	VH 16/5/3,5 SAK10-35			0309700000		