

GOT 1000

Graphic Operation Terminals

More Perspective in the Automation

From data display to problem solution platform

Now with the
new GT12 series!



Powerful 64-bit RISC processor and high memory capacity means faster operation and clearer displays



Easy access USB port for programming and maintenance



Manifold possibilities for storing and transporting project data



Full iQ platform integration possibility

Clear vision



HMI's can help users see what is happening anywhere in their process, like in a PET production.



Mitsubishi GOTs help you to keep the look through.

More than just an operation terminal

Mitsubishi Electric has once again set new standards in human machine communication with the new GOT1000 series of touch-screen operation terminals. Providing the features customers have been asking for was a top priority in the design of these units – combined with advanced technology and the experience drawn from a long history of HMI design. The result is products that will make work easier for programmers and service staff as well as operators.

Powerful technology

These new terminals don't just look good, they are also packed with many powerful features:

■ Expressive high-resolution screens

The high-resolution screens, with up to 65,536 colours, can display complex graphics, photos and even CAD drawings. User inputs are made by touching the screen (touch-screen).

■ High-speed processing

The 64-bit RISC processor used in the GOT1000 series is combined with a specially developed high-speed graphics processor. Together, they deliver impressive response and display drawing times.



Easy to use touch screen

■ USB port

Thanks to the integrated* USB port an easy data transfer is possible. This connection can also be used for programming and diagnostics with a MELSEC PLC or further automatization devices. With the units, where the port is located on the frontside (see table on the back for details), it is possible to transfer project data without opening the cabinet or control console. These ports come with a secure cover that maintains the IP67 protection rating.

*not for GT1020/1030

■ More flexibility with portable operation terminals

The GOT series range covers also portable versions (Handy GOTs), which allow a flexible usage of the operation terminal at the respective application.



Application directly at the machine

Innovative design

The GOT1000 series' innovative error reporting system ensures fast troubleshooting and minimum downtime. Predefined screens provide direct access to the PLC's I/Os and even the buffer memory of special-function modules.



Versatile and multi-lingual

Extended protocol support

In addition to the wide ranging support for Mitsubishi PLC's, frequency inverters and servo amplifiers, GOT1000 series can also be connected to an increasing range of automation products from other manufacturers. This enables users to start to build a common visualization strategy for their business.

Multi-language with Unicode 2.1

Support for Unicode 2.1 enables users to easily create multi-language displays. This can then help companies who export machines to sell and support their products globally.

Scripts for reduced PLC load

The processing load applied to the connected PLC CPU or other automation equipment can be reduced when the GOT processes scripts. These scripts are unique to the GOT and are similar to the C programming language. They allow programmers to use their favorite commercial editors to move some of the processing activities from the PLC into the GOT.



Brilliant colours in high resolution

Improved screen design software



The GT Works software package from Mitsubishi Electric is an extended suite of programming, control and visualisation tools with full support for the GOT family of terminals.

The main component is the user-friendly and intuitive GT Designer operation terminal management program. A comprehen-

sive library of ready-to-use graphical objects and a large selection of fonts makes it easy to produce effective user screens. Furthermore, the integrated GT Simulator allows a quick and efficient set up process for all GOT terminals.

Also included is the GT-SoftGOT1000 software, which enables you to run GOT projects on a PC without the GOT hardware – turning the PC into a powerful PC-based HMI system.



Specifications ///

Technical data		GT10 (10 units)	GT11 (4 units)	GT12 (2 units)	GT15 (24 units)	GT16 (12 units)
Display	type	STN	STN	TFT	STN, TFT	TFT
	dimensions (diagonal)	3.7"–4.5"	5.7"	8.4"–10.4"	5.7"–15"	8.4"–15"
	text (lines x characters)	Freely definable	Freely definable	Freely definable	Freely definable	Freely definable
	character height (mm)	Freely definable, Windows fonts	Freely definable, Windows fonts	Freely definable, Windows fonts	Freely definable, Windows fonts	Freely definable, Windows fonts
	max. resolution (pixle)	160 x 64/288 x 96	320 x 240	640x480	320 x 240 to 1024 x 768	640 x 480 to 1024 x 768
Power supply		5 V DC/24 V DC	24 V DC	100–220 V AC	24 V DC/220 V AC	24 V DC/220 V AC
Memory capacity		512 KB/1.5 MB	3 MB	6 MB	5–9 MB (expandable to 57 MB)	15 MB (expandable to 57 MB)
External memory card		—	1 (CF, 2 GB max.)	1 (CF, 2 GB max.)	1 (CF, 2 GB max.)	1 (CF, 2 GB max.)
Key type		Touch panel	Touch panel	Touch panel	Touch panel	Touch panel
Function keys		Touch keys	Touch keys + 6 function keys	Touch keys	Touch keys	Touch keys
LED indicators		—	1 (Power ON)	1 (Power ON)	1 (Power ON)	1 (Power ON)
Interfaces	serial	2 x RS232, RS422/RS232	RS232C, RS422	RS232, RS422/RS485	RS232	RS232, RS422/RS485
	others	USB wiht out GT1020/1030	USB	USB	USB (at the front)	2 x USB (at the front)
Networks capability		Serial	Serial	Ethernet (TCP/IP)	Ethernet (TCP/IP), CC-Link, RS422, RS485, A-Bus, Q-Bus, MELSECNET/10/H	Ethernet (TCP/IP), CC-Link, RS422, RS485, A-Bus, Q-Bus, MELSECNET/10/H
Protection (front)		IP67	IP67/IP65 (Handy GOTs)	IP67	IP67	IP67

GT1020/
GT1030

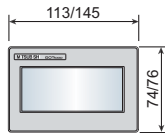

GT1040, 1045/
GT1050, 1055

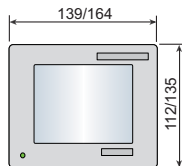

GT1150, GT1155

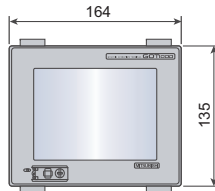

Handy GOTs

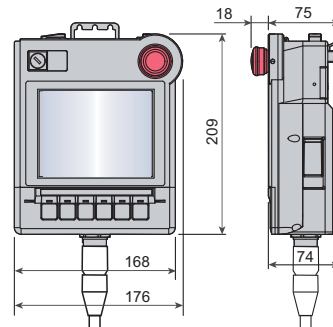

GT1550, GT1555

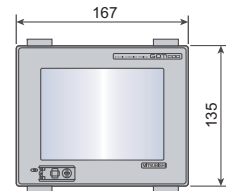

GT1265, GT1562,
GT1565, GT1665

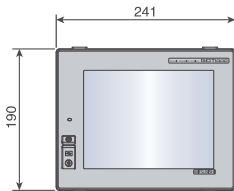

GT1275, GT1572,
GT1575, GT1675

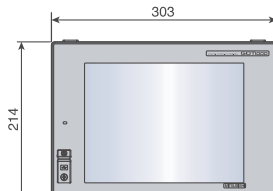

GT1585, GT1685

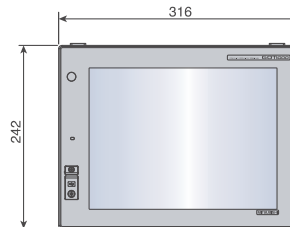

GT1595, GT1695

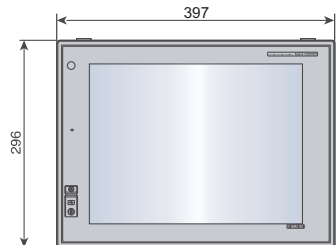

All dimensions in mm

EUROPEAN BRANCHES

MITSUBISHI ELECTRIC EUROPE B.V. CZECH REPUBLIC Radická 714/113a CZ-158 00 Praha 5 Phone: +420 (0)251 551 470	MITSUBISHI ELECTRIC EUROPE B.V. FRANCE 25, Boulevard des Bouvets F-92741 Nanterre Cedex Phone: +33 (0)155 68 55 68	MITSUBISHI ELECTRIC EUROPE B.V. GERMANY Gothaer Straße 8 D-40880 Ratingen Phone: +49 (0)2102/486-0	MITSUBISHI ELECTRIC EUROPE B.V. IRELAND Westgate Business Park, Ballymount IRL-Dublin 24 Phone: +353 (0)1 4198800	MITSUBISHI ELECTRIC EUROPE B.V. ITALY Viale Colleoni 7 I-20041 Agrate Brianza (MB) Phone: +39 039/60 53 1	MITSUBISHI ELECTRIC EUROPE B.V. SPAIN Carrerera de Rubí 76-80 E-08190 Sant Cugat del Vallés (Barcelona) Phone: +34 935653131	MITSUBISHI ELECTRIC EUROPE B.V. UK Travellers Lane UK-Hatfield, Herts. AL10 8XB Phone: +44 (0)1727 61 61 00
--	--	--	---	---	--	---

EUROPEAN REPRESENTATIVES

GEVA Austria Wiener Straße 89 AT-2500 Baden Phone: +43 (0)2252/85 55 20	TEHNIKON Belarus Oktyabrskaya 16/5, Off. 703-711 BY-220030 Minsk Phone: +375 (0)17/210 46 26	ESCO D & A Belgium Culliganlaan 3 BE-1831 Diegem Phone: +32 (0)2/257 02 40	Koning & Hartman b.v. Belgium Woluwelaan 31 BE-1800 Vilvoorde Phone: +32 (0)33/921 164	INEA BH d.o.o. BOSNIA and Herzeg. Aleja Lipa 56 BA-71000 Sarajevo Phone: +387 (0)33/921 164	AKHNATON Bulgaria 4 Andrej Ljapchev Blvd. Pp 21 BG-1756 Sofia Phone: +359 (0)2/817 6004	INEA CR d.o.o. Croatia Losinjka 4 a HR-10000 Zagreb Phone: +385 (0)1/36 940 - 01/ -02/-03	AutoCont C.S. s.r.o. CZECH REPUBLIC Technologická 374/6 CZ-708 00 Ostrava-Pustkovec Phone: +420 595 691 150	B:TECH A.S. CZECH REPUBLIC U Borové 69 CZ-58001 Havlíčkův Brod Phone: +420 (0)569 777 777	ESCO D & A Denmark Bejler Electronics A/S Lykkegårdsvej 17, 1. DK-4000 Roskilde Phone: +45 (0)46/ 75 76 66	Bejler Electronics Eesti OÜ Estonia Pärnu mnt.160i EE-11317 Tallinn Phone: +45 (0)16/51 81 40	INEA SR d.o.o. Finland Jaakonkatu 2 FIN-01620 Vantaa Phone: +358 (0)207/463 500	UTECO A.B.E.E. Greece 5, Mavrogenous Str. GR-18542 Piraeus Phone: +30 211/1206 900	MELTRADE Ltd. Hungary Fertő utca 14. HU-1107 Budapest Phone: +36 (0)1/431-9726	KAZPROMAUTOM. Ltd. Kazakhstan Mustafina Str. 7/2 KAZ-470046 Karaganda Phone: +7 7212/50 11 50	Bejler Electronics SIA Latvia Vestienas iela 2 LV-1035 Riga Phone: +371 (0)784/2280	Bejler Electronics UAB Lithuania Savanoriu Pr. 187 LT-02300 Vilnius Phone: +370 (0)5/232 31 01	ALFATRADE Ltd. Malta 99, Paola Hill Malta- Paola PLA 1702 Phone: +356 (0)21/697 816	INTEHSIS srl Moldova bld. Traian 23/1 MD-2060 Kishinev Phone: +373 (0)22/66 4242	HIFLEX AUTOM. B.V. Netherlands Wolweverstraat 22 NL-2984 CD Ridderkerk Phone: +31 (0)180 - 46 60 04	Koning & Hartman b.v. Netherlands Haarlerbergweg 21-23 NL-1101 CH Amsterdam Phone: +31 (0)20/587 76 00	Bejler Electronics AS Norway Postboks 487 NO-3002 Drammen Phone: +47 (0)32/24 30 00	MPL Technology Sp. z o.o. Poland Ul. Krakowska 50 PL-32-083 Balice Phone: +48 (0)12/630 47 00	Sirius Trading & Services Romania Aleea Lacul Morii Nr. 3 RO-060841 Bucuresti, Sector 6 Phone: +40 (0)21/430 40 06	Craft Con. & Engineering d.o.o. Serbia Bulevar Svetog Cara Konstantina 80-86 SER-18106 Nis Phone: +381 (0)18/292-24-4/5	INEA SR d.o.o. Serbia Izletnička 10 SER-113000 Smederevo Phone: +381 (0)26/617 163	AutoCont Control s.r.o. Slovakia Radlinského 47 SK-02601 Dolný Kubín Phone: +421 (0)43/5868210	CS MTrade Slovensko, s.r.o. Slovakia Vajanského 58 SK-92101 Piestany Phone: +421 (0)33/7742 760	INEA d.o.o. Slovenia Stegne 11 SI-1000 Ljubljana Phone: +386 (0)1/513 8100	Bejler Electronics AB Sweden Box 426 SE-20124 Malmö Phone: +46 (0)40/35 86 00	Econotec AG Switzerland Hinterdorfstr. 12 CH-8309 Nürensdorf Phone: +41 (0)44/838 48 11	GTS Turkey Bayraktar Bulvarı Nutuk Sok. No:5 TR-34775 Yukarı İSTANBUL Phone: +90 (0)216 526 39 90	CSC Automation Ltd. Ukraine 4-B, M. Raskovoyi St. UA-02660 Kiev Phone: +380 (0)44/494 33 55	ILAN & GAVISH Ltd. Israel 24 Shenkar St., Kiryat Arie IL-49001 Petah-Tiqva Phone: +972 (0)3/922 18 24	CEG INTERNATIONAL Lebanon Cebaco Center/Block A Autostrade DORA Lebanon - Beirut Phone: +961 (0)1/240 430	CBI Ltd. South Africa Private Bag 2016 ZA-1600 Isando Phone: +27 (0)11/928 2000
---	--	--	--	---	---	---	---	---	---	---	---	--	--	---	---	--	---	--	---	--	---	---	--	---	--	--	---	--	---	---	---	---	---	---	---



Mitsubishi Electric Europe B.V. /// FA - European Business Group /// Gothaer Straße 8 /// D-40880 Ratingen /// Germany
Tel.: +49(0)2102-4860 /// Fax: +49(0)2102-4861 120 /// info@mitsubishi-automation.com /// www.mitsubishi-automation.com

Specifications subject to change /// Art. no. 163197-F /// 08.2010

All trademarks and copyrights acknowledged.