

Terminal boxes HD

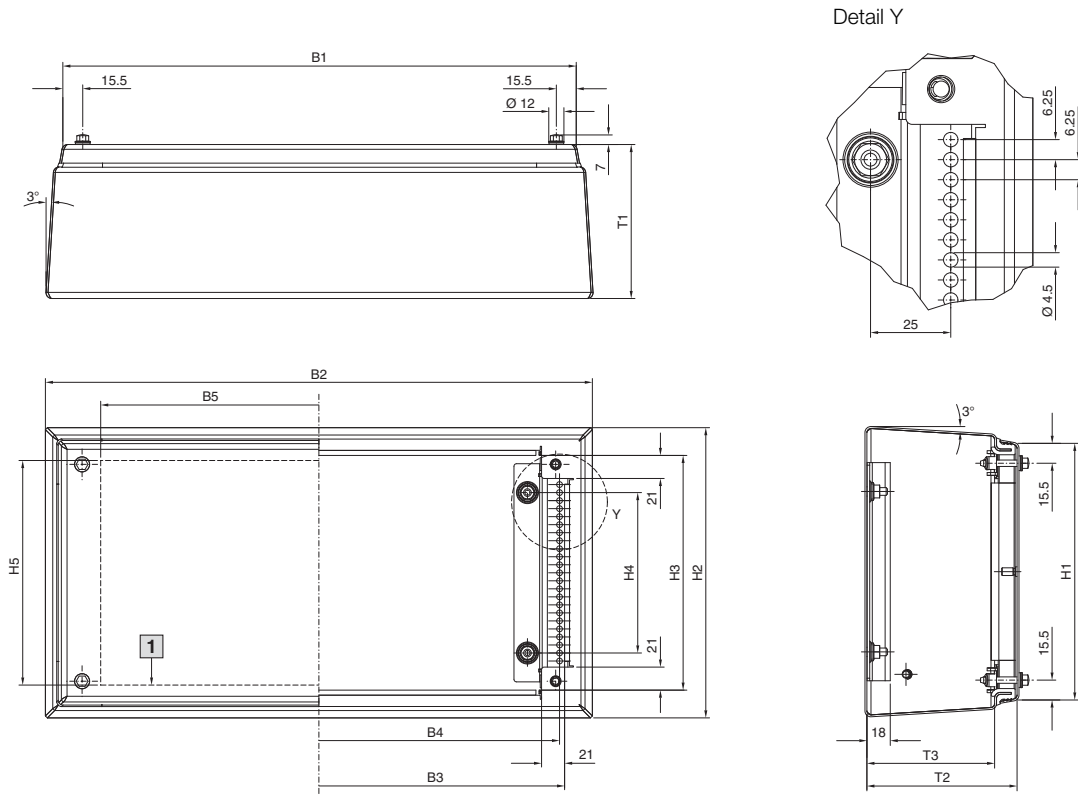

1 Max. installation area, cover

Model No. HD	Width dimensions mm					Height dimensions mm					Depth dimensions mm		
	B1	B2	B3	B4	B5	H1	H2	H3	H4	H5	T1	T2	T3
1670.600	150	171.3	138.2	125	90	150	171.3	138.2	75	125	80	77	59.5
1671.600	150	176.2	138.2	125	90	150	176.2	138.2	75	125	120	117	99.5
1672.600	200	226.2	188.2	175	140	200	226.2	188.2	125	175	120	117	99.5
1674.600	300	326.2	288.2	275	240	200	226.2	188.2	125	175	120	117	99.5
1675.600	400	426.2	388.2	375	340	200	226.2	188.2	125	175	120	117	99.5
1676.600	400	426.2	388.2	375	340	300	326.2	288.2	225	275	120	117	99.5

B1 = Total width, top
 B2 = Total width, bottom
 B3 = Clearance width
 B4 = Distance between system punchings
 B5 = Max. installation width, cover

H1 = Total height, top
 H2 = Total height, bottom
 H3 = Clearance height
 H4 = Distance between fixing bolts
 H5 = Max. installation height, cover

T1 = Total depth
 T2 = Clearance depth, enclosure cover
 T3 = Clearance depth, enclosure

Enclosures

Hygienic Design

Compact enclosures HD, single-door

HD 1316.600, HD 1317.600

HD 1302.600, HD 1306.600, HD 1307.600,
HD 1308.600, HD 1310.600, HD 1320.600

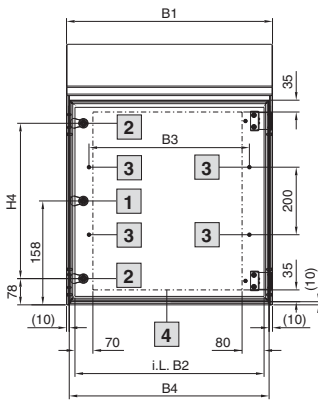

- 1 For HD 1302.600
- 2 For HD 1306.600, HD 1307.600, HD 1308.600, HD 1310.600, HD 1320.600
- 3 For HD 1307.600, HD 1308.600, HD 1310.600

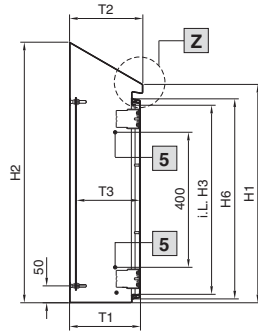

- 4 Max. installation area, door
- 5 For HD 1308.600, HD 1310.600

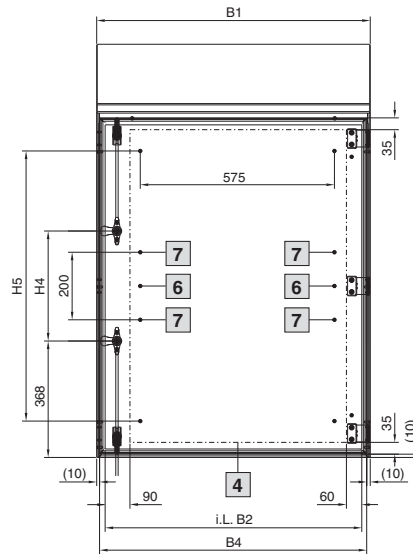

- 6 For HD 1316.600
 - 7 For HD 1317.600
- i.L. = Clearance width

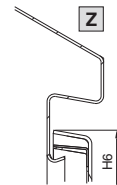
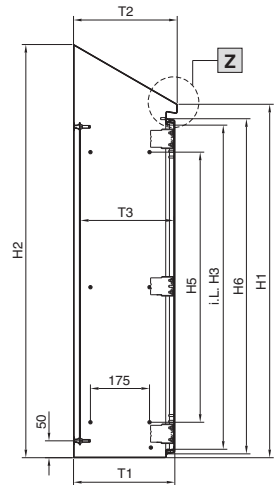

HD 1317.600

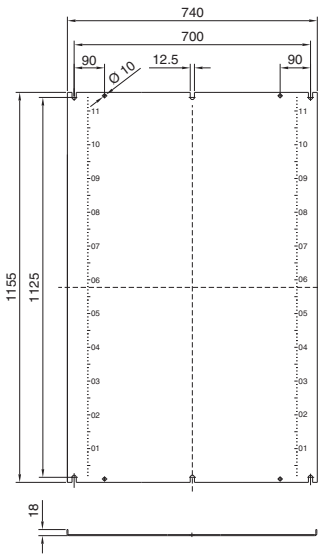

HD 1316.600

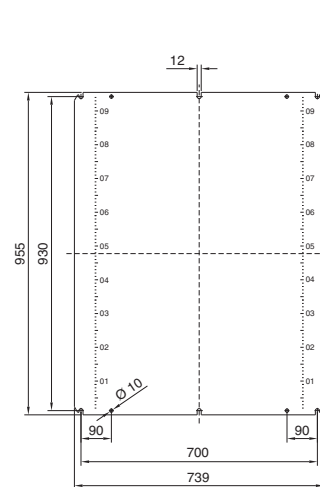

HD 1306.600, HD 1307.600,
HD 1308.600, HD 1310.600,
HD 1320.600

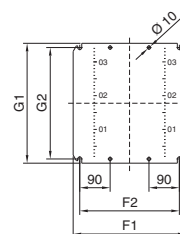

HD 1302.600

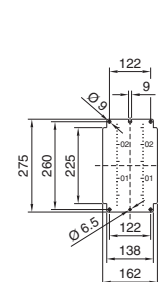

Mounting plate

- F1 = Mounting plate width
- F2 = Separation width of attachment holes
- G1 = Mounting plate height
- G2 = Separation width of attachment holes

Enclosure

- B1 = Overall width
- B2 = Clearance width of enclosure
- B3 = Separation width of threaded bolts on the door
- B4 = Width of door

- H1 = Enclosure height, front
- H2 = Enclosure height, rear
- H3 = Clearance height of enclosure
- H4 = Spacing between fasteners
- H5 = Separation height of threaded bolts on the door
- H6 = Height of door

- T1 = Depth between rear panel and door
- T2 = Overall depth
- T3 = Possible mounting depth (mounting plate assembly)

Model No. HD	Width dimensions mm				Height dimensions mm						Depth dimensions mm			Mounting plates mm				Material thickness mm		
	B1	B2	B3	B4	H1	H2	H3	H4	H5	H6	T1	T2	T3	F1	F2	G1	G2	Enclosure	Door	Mounting plate
1302.600	220	170	-	200	350	437	260	-	-	293	155	162	113 - 130	-	-	-	-	1.5	1.5	2.0
1306.600	390	340	-	370	430	549	340	240	-	373	210	217	168 - 185	334	295	355	330	1.5	1.5	2.0
1307.600	510	460	375	490	550	669	460	360	-	493	210	217	168 - 185	449	410	470	445	1.5	1.5	2.5
1308.600	390	340	275	370	650	769	560	460	-	593	210	217	168 - 185	334	295	570	545	1.5	1.5	2.5
1310.600	610	560	475	590	650	769	560	460	-	593	210	217	168 - 185	549	510	570	545	1.5	2.0	2.5
1316.600	810	760	-	790	1050	1221	960	280	800	993	300	307	258 - 275	-	-	-	-	1.5	2.0	3.0
1317.600	810	760	-	790	1250	1421	1160	480	1000	1193	300	307	258 - 275	-	-	-	-	1.5	2.0	3.0
1320.600	610	560	-	590	430	601	340	240	-	373	300	307	258 - 275	549	510	355	330	1.5	1.5	2.5