

Luminescence
scanners

LUT Luminescence scanners: Seeing what no-one else can

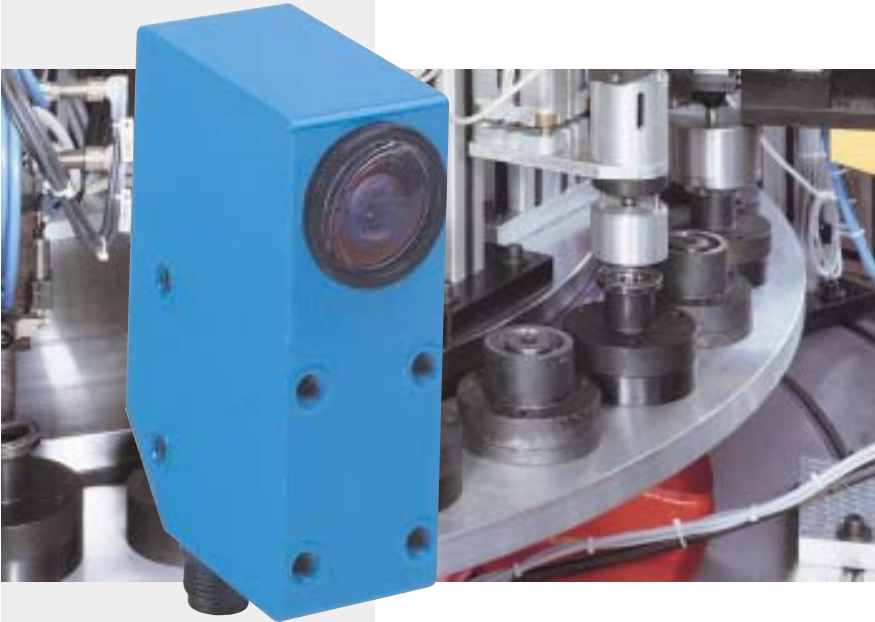

Special features:

- A semi-conductor light source is used in the LUT 3 series – no lamp change required.
- Interchangeable lenses allow scanning distances of 10, 20, 50 and 90 mm.
- Filters allow the spectral sensitivity to be limited so that the sensor can be adapted to detect certain luminophores.
- The high switching frequency of 1500/s permits fast machine cycle times.
- Adjustable time delay, analogue output, PNP and NPN switching outputs.

LUT luminescence scanners can detect luminophores (both natural and those that have been deliberately added or attached for product identification purposes) which are invisible to the naked eye. These substances become luminous when the UV light source of the LUT excites the electrons of the luminophores. The visible light produced in this way is used to detect the target object. The background on which the luminophores are attached has no effect on the reliability of detection.

Checking packaging processes, controlling wood-working machines and monitoring the application of a material coating – just a few examples of applications where luminophores are reliably detected by LUT luminescence scanners.



▲ Luminescence scanners being used to align aerosol cans.



◀ Label present or not: the LUT 3-8 knows the answer (here being used in the pharmaceutical industry).

▼ LUT 1-4 luminescence scanners used to ensure that brake callipers for vehicles are correctly fed in.

► Reliable attachment of labels: The LUT 3 luminescence scanner checking whether the label has been transferred from the glue-spreading roller to the bottle.



▲ Once a fluorescent marking has been applied during quality control, tiles can be sorted automatically into quality categories using a luminescence scanner.

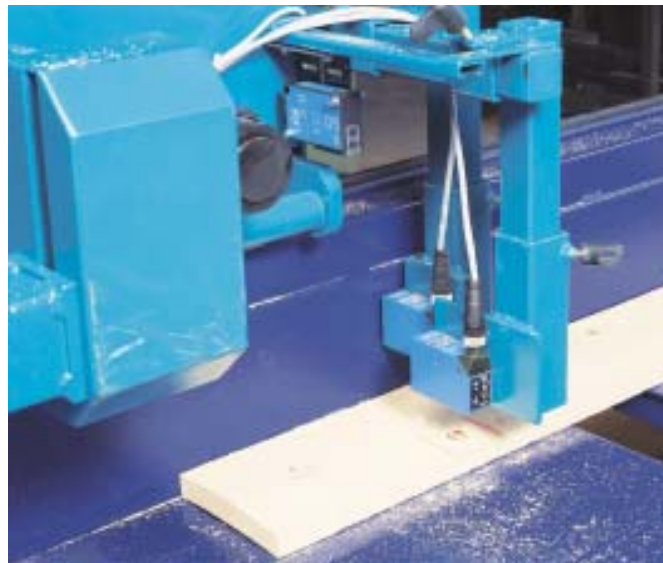

◀ LUT 3-8 luminescence scanner with filter for detecting markings used to control a circular saw.

Scanning distance
10...50 mm

Luminescence scanners

- UV semi-conductor light source
- No lamp replacement
- Scanning distance selectable by using interchangeable lenses



Accessories	page
Cable receptacles	496
Lenses	556

Dimensional drawing

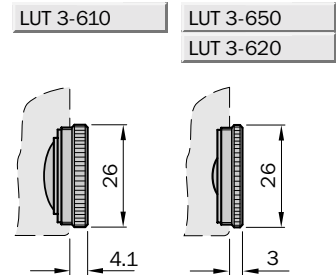
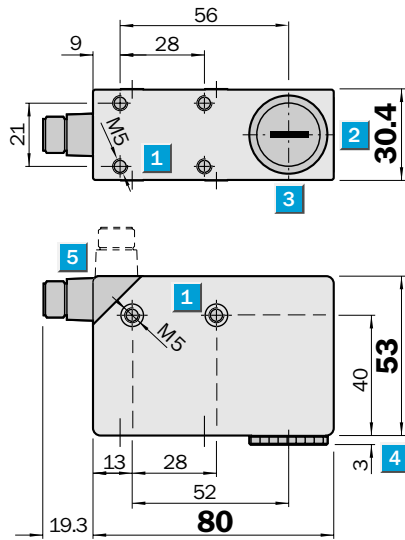

Adjustments possible

All types

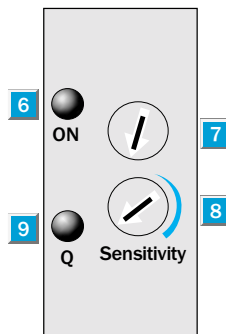

- 1 M 5 threaded mounting hole, 5.5 mm deep
- 2 Light spot direction
- 3 Centre of optical axis
- 4 See dimensional drawing for lens
- 5 M 12 plug (rotatable)
- 6 Operating indicator
- 7 Not used
- 8 Sensitivity adjustment
- 9 Output indicator

Connection type

All types

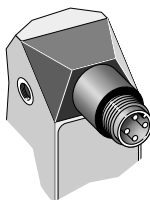

4-pin, M 12

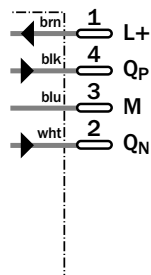

Technical Data		LUT 3-	610	620	650								
Scanning distance^{1)/}	10 mm/2 x 6 mm												
light spot sizes	20 mm/3 x 9 mm												
	50 mm/5 x 15 mm												
Light spot direction	Longitudinal												
Light source^{2), light type}	UV light source												
Wavelength	380 nm												
Supply voltage V_S	12...30 V DC ³⁾												
Ripple ⁴⁾	max. 2 V												
Current consumption ⁵⁾	60 mA												
Switching outputs	Light-switching												
	PNP: HIGH = V _S - <3 V/LOW = 0 V												
	NPN: HIGH = V _S /LOW = <2 V												
Output current I _A max.	100 mA												
Response time ⁶⁾	0.3 ms												
Switching frequency ⁷⁾	1.5 kHz												
Connection type	Plug												
VDE protection class⁸⁾	□												
Circuit protection⁹⁾	A, B, C												
Enclosure rating	IP 67												
Ambient temperature T_A	Operation - 10 °C... + 55 °C												
	Storage - 25 °C... + 75 °C												
Shock load	To IEC 68												
Weight	Approx. 400 g												
Housing material	Die-cast metal												

- 1) From front edge of lens
 2) Average service life 100,000 h
 at T_A = +25 °C
 3) Limit values

- 4) May not exceed or fall short of
 V_S tolerances
 5) Without load

- 6) Signal transit time with resistive load
 7) With light/dark ratio 1:1
 8) Reference voltage DC 50 V

- 9) A = V_S connections reverse-polarity
 protected
 B = Outputs Q_P and Q_N short-circuit
 protected
 C = Interference pulse suppression

Scanning distance

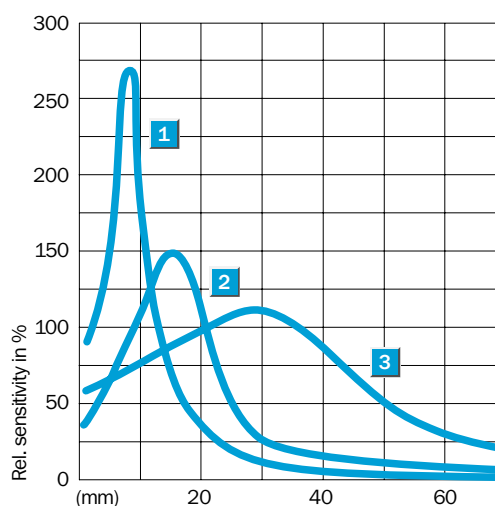

1	Scanning distance	10 mm
2	Scanning distance	20 mm
3	Scanning distance	50 mm

Order information

Type	Part no.
LUT 3-610	1 015 396
LUT 3-620	1 015 397
LUT 3-650	1 015 398

LUT 3-6 is not supplied with additional filter or fibre-optic cable

OBJ-LUT 3-10	2 016 348
OBJ-LUT 3-20	2 016 349
OBJ-LUT 3-50	2 016 350

Scanning distance
10...90 mm

Luminescence scanners

- UV semi-conductor light source
- No lamp replacement
- Scanning distance selectable by using interchangeable lenses
- Fibre-optic cable connection
- Analogue output
- Additional optical filter



Dimensional drawing

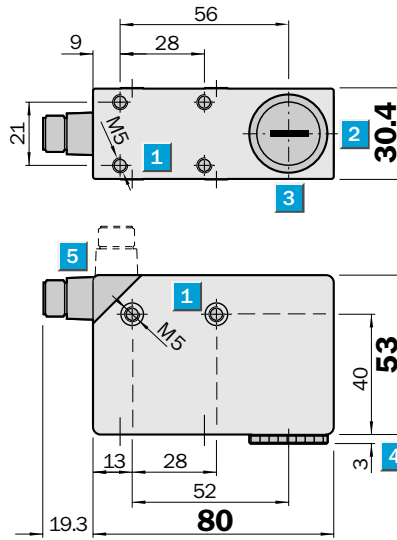

LUT 3-810	LUT 3-820
LUT 3-910	LUT 3-850
	LUT 3-851
	LUT 3-852
	LUT 3-853
	LUT 3-920
	LUT 3-950
	LUT 3-951
	LUT 3-952
	LUT 3-953

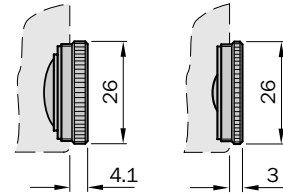

LUT 3-890

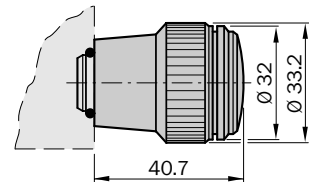

Adjustments possible

All types

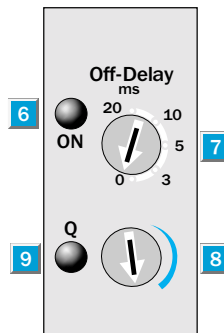

- 1 M5 threaded mounting hole, 5.5 mm deep
- 2 Light spot direction
- 3 Centre of optical axis
- 4 See dimensional drawing for lens
- 5 M 12 plug (rotatable)
- 6 Operating indicator
- 7 Time delay selector switch
- 8 Sensitivity adjustment
- 9 Output indicator

Connection type

All types

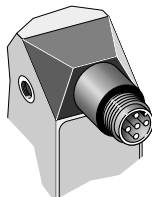

5-pin, M 12

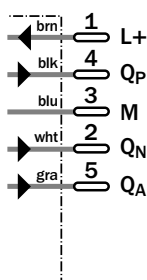

Accessories	page
Cable receptacles	496
Lenses	556



Technical Data		LUT 3-	810	820	850	890	851	852	853	910	920	950
Scanning distance ^{1)/}	10 mm/2 x 6 mm											
Light spot sizes	20 mm/3 x 9 mm											
	50 mm/5 x 15 mm											
	90 mm/8 x 20 mm											
Light spot direction	Longitudinal											
Light source ^{2), light type}	UV light source											
Wavelength	385 nm											
	370 nm											
Receiver filter	OG 570											
	RG 610											
	RG 665											
Supply voltage V_S	12...30 V DC ³⁾											
Ripple ⁴⁾	max. 2 V											
Current consumption ⁵⁾	60 mA											
Switching outputs	Light-switching											
	PNP: HIGH = $V_S - <3$ V/LOW = 0 V											
	NPN: HIGH = V_S /LOW = <2 V											
Output current I_A max.	100 mA											
Response time ⁶⁾	0.3 ms											
Switching frequency ⁷⁾	1.5 kHz											
Time delay (deactivation delay)	3 ms, 5 ms, 10 ms, 20 ms, adjustable											
Analogue output Q_A	0.5...10 mA, 800 Ω											
Connection type	Plug											
VDE protection class ⁸⁾	<input type="checkbox"/>											
Circuit protection ⁹⁾	A, B, C											
Enclosure rating	IP 67											
Ambient temperature T_A	Operation -10 °C...+55 °C											
	Storage -25 °C...+75 °C											
Shock load	To IEC 68											
Weight	Approx. 400 g											
Housing material	Die-cast metal											

- 1) From front edge of lens
 2) Average service life 100,000 h
 at $T_A = +25$ °C
 3) Limit values

- 4) May not exceed or fall short of
 V_S tolerances
 5) Without load

- 6) Signal transit time with resistive load
 7) With light/dark ratio 1:1
 8) Reference voltage DC 50 V

- 9) A = V_S connections reverse-polarity
 protected
 B = Outputs Q_P and Q_N short-circuit
 protected
 C = Interference pulse suppression

Scanning distance	1	2	3	4
Scanning distance	10 mm	20 mm	50 mm	90 mm

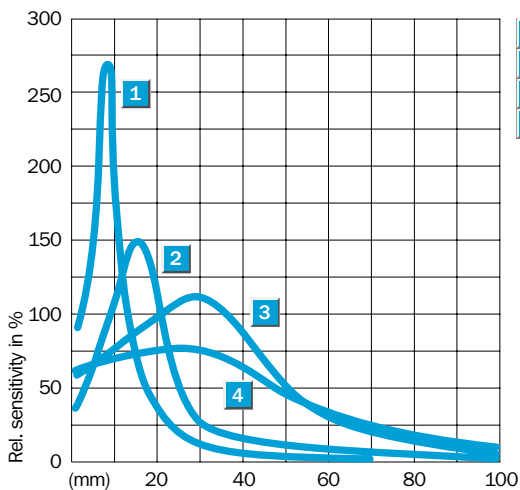

Order information	
Type	Part no.
LUT 3-810	1 012 867
LUT 3-820	1 012 868
LUT 3-850	1 012 869
LUT 3-890	1 014 058
LUT 3-910	1 019 285
LUT 3-920	1 019 286
LUT 3-950	1 019 287

With additional optical filters

LUT 3-851	1 012 870
LUT 3-852	1 012 871
LUT 3-853	1 012 872
LUT 3-951	1 019 288
LUT 3-952	1 019 289
LUT 3-953	1 019 290

Scanning distance
10...90 mm

Luminescence scanners

- UV semi-conductor light source with high-pressure mercury vapour lamp
- Scanning distance selectable by using interchangeable lenses
- Fibre-optic connection
- Additional optical filter



Accessories	page
Cable receptacles	496
Fibre-optic cable	552
Lenses	556

Dimensional drawing

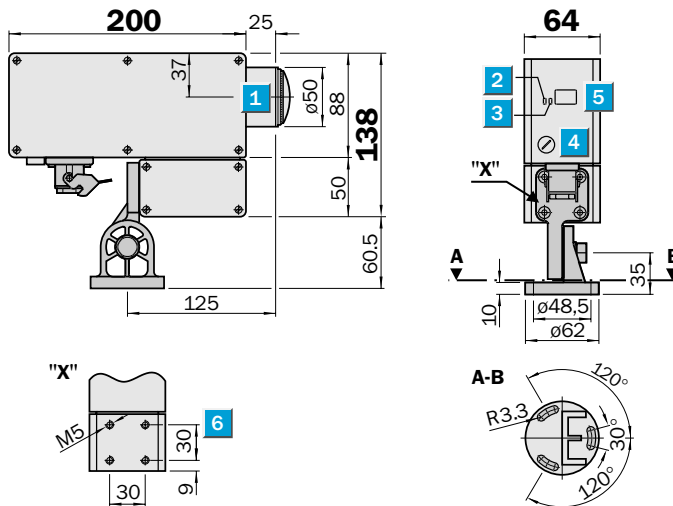

Adjustments possible

All types

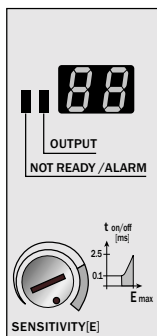

LUT 1-410	LUT 1-430	LUT 1-450
LUT 1-420	LUT 1-440	

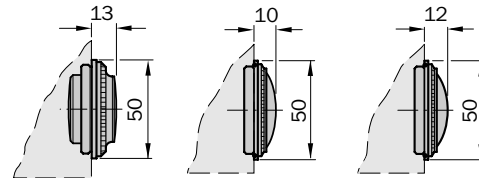

- 1 Lens, see dimensional drawing
- 2 Readiness indicator
- 3 Status indicator
- 4 Sensitivity adjustment
- 5 Digital intensity signal
- 6 Threaded mounting hole, 12 mm deep

Connection type

Bridge

LUT 1-4

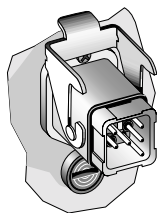

7-pin + PE

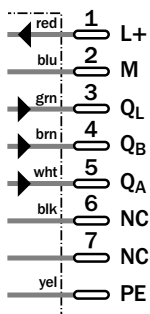

Truth table LUT 1-4

Internal jumper	o a o b o			o a o b o		
	Delivered state					
Switching type	Light-switching			Dark-switching		
Sender lamp	off	started		off	started	
Luminescence	-	yes	no	-	yes	no
Output Q _B (PNP)	LOW	HIGH		LOW	HIGH	
Readiness indicator (red)	on	off/flashing*		an	off/flashing*	
Output Q _L (PNP)	LOW	HIGH	LOW	LOW	LOW	HIGH
Status indicator (green)	off	on	off	off	on	off

* Flashing: lamp power still sufficient for operation

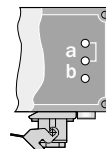

Technical Data		LUT 1-	400	410	420	430	440	450				
Scanning distance^{1)/}	10 mm/∅ 3 mm											
light spot diameter	20 mm/∅ 4 mm											
	50 mm/∅ 8 mm											
	125 mm/∅ 15 mm											
	300 mm/∅ 40 mm											
With fibre-optic cable, no lens	8 mm/∅ 10 mm											
With fibre-optic cable, with 144 lens	15 mm/∅ 6 mm											
With fibre-optic cable, with 144 lens and diaphragm	15 mm/∅ 3 x 6 mm											
Light source	High-pressure mercury vapour lamp											
Light type, wavelength	UV, 365 nm											
Average service life	4000 h											
Supply voltage V_S	18...30 V DC ²⁾											
Ripple ³⁾	2 V											
Current consumption ⁴⁾	700 mA											
Switching outputs Q_L⁵⁾ and Q_B⁶⁾	Light-/dark-switching, selectable PNP: HIGH = V _S - <2 V/LOW = 0 V											
Output current I _A max.	200 mA											
Max. switching frequency ⁷⁾	5 kHz											
At max. sensitivity	200 Hz											
Response time	0.1 ms											
At max. sensitivity	2.5 ms											
Analogue output Q_A	0...1.5 V											
Connection type	Plug											
VDE protection class⁸⁾	<input type="checkbox"/>											
Circuit protection⁹⁾	A, B, C											
Enclosure rating	IP 63											
Ambient temperature	Operation 0 °C...+45 °C Storage -25 °C...+75 °C											
Weight	2.5 kg											
Housing material/surface	Die-cast metal											

- 1) From front edge of lens
2) Limit values
3) May not exceed or fall short of V_S
4) Without load

- 5) Q_L = signal output
6) Q_B = operational readiness

- 7) With light/dark ratio 1:1
8) Reference voltage DC 50 V

- 9) A = V_S connections reverse-polarity protected
B = Outputs Q_L, Q_B and Q_{LU} short-circuit protected
C = Interference pulse suppression

Scanning distance		Order information			
	1	Scanning distance	10 mm	Type	Part no.
	2	Scanning distance	20 mm	LUT 1-400	1 007 626
	3	Scanning distance	50 mm	LUT 1-410	1 005 935
	4	Scanning distance	125 mm	LUT 1-420	1 005 936
	5	Scanning distance	300 mm	LUT 1-430	1 005 937
				LUT 1-440	1 005 938
				LUT 1-450	1 005 939
Special accessories					
Colour filter					
		Type	Wavelength	Part no.	
		OBF-OG 570-4	570...750 nm	4 005 810	
		OBF-RG 610-4	610...750 nm	4 012 735	
		OBF-RG 630-4	630...750 nm	4 014 153	
		OBF-RG 665-4	665...750 nm	4 014 154	
Spare lamp					
		SLA-LUT 1-4		1 002 262	